

M. 1:1

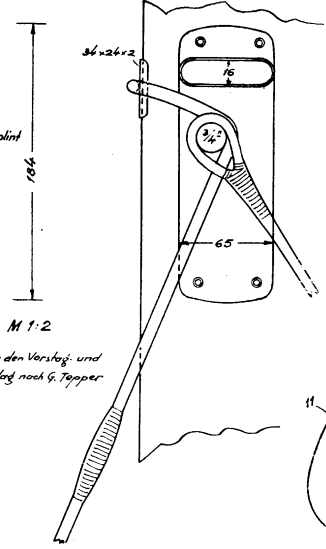

Variante fur den Vorstag und Handbeschlag nach G. Topper

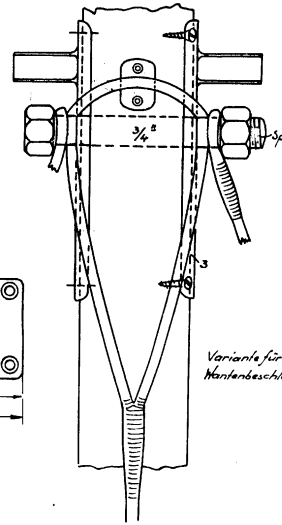
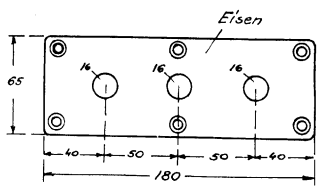
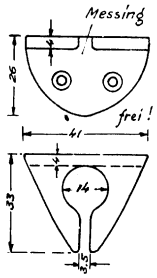
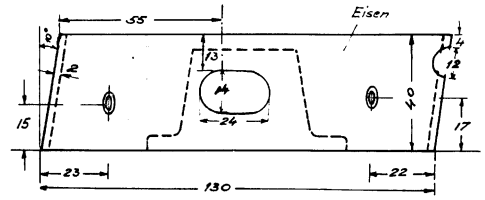
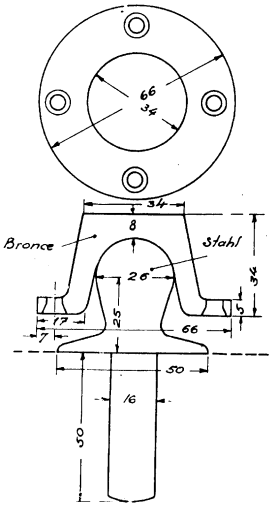
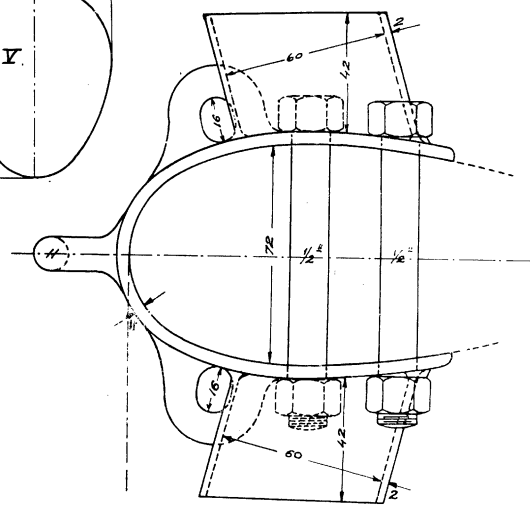
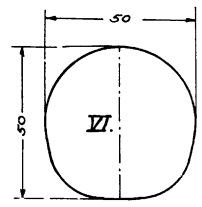
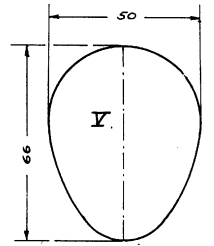
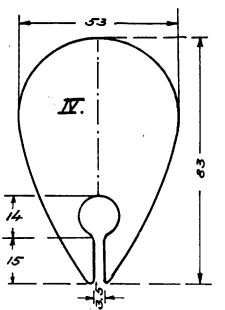
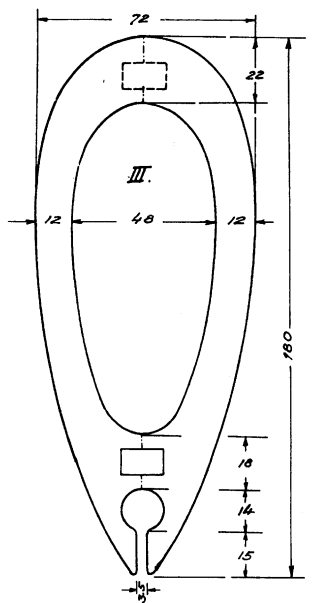
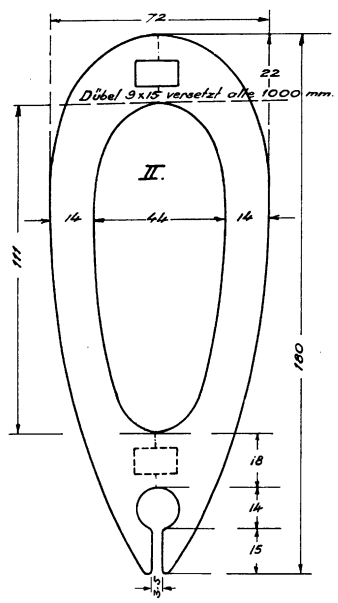